



- MAP Industry Group
- 43 West 33rd Street Suite 200
- New York NY 10001 USA
- Tel (212) 252-2207 · Fax (800) 961-4568
- info@maptowers.com www.maptowers.com

QUADROPARKER N4904

THE IDEAL SOLUTION FOR THE EXTERIORS; ON 4 LEVELS



SHORT DESCRIPTION

INDEPENDENT PARKING SYSTEM ON 4 LEVELS
 LOWER LEVELS: SYSTEM COLUMNS ON THE CORNERS
 UPPER LEVEL: WITHOUT COLUMNS
 INDIVIDUAL CONFIGURATION POSSIBILITIES FOR THE UPPER
 PLATFORM AVAILABLE ON REQUEST (e.g. WOODEN COVERING)
 SINGLE (4 CARS) AND DOUBLE SYSTEM (8 CARS)
 LOAD PER PARKING SPACE: 2.000 KG (STANDARD)
 UP TO 2.600 KG (OPTIONAL)

APPLICATION

FOR EXTERIORS, WITH PIT
 SINGLE-FAMILY DWELLINGS
 MULTI-FAMILY DWELLINGS
 HOTELS
 OFFICE BUILDINGS
 CONDOMINIUMS
 COMMERCIALS
 FOR PERMANENT USERS ONLY

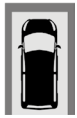

S-system
for 2 cars

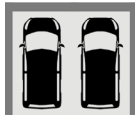

D-system
for 4 cars

NOTE

The total height of the car including roof rail and antenna fixture must not exceed the maximum car height mentioned in the table below. Standard cars do not feature sport equipment (e.g. spoiler, etc.)



The upper platform by N4904-D is designed for only parking the vehicle. Lifting the system with vehicle on the upper platform is NOT possible.

Horizontally accessible platforms

For permanent and instructed users only

All dimensions in cm

In case of partition walls:
10x10 cm wall opening
(position: +/- 0 m)
for electrical and hydraulic lines

Load per parking space: max. 2.000kg,
wheel load: max. 500kg. Optional: max.
2.600kg, wheel load: max. 650kg

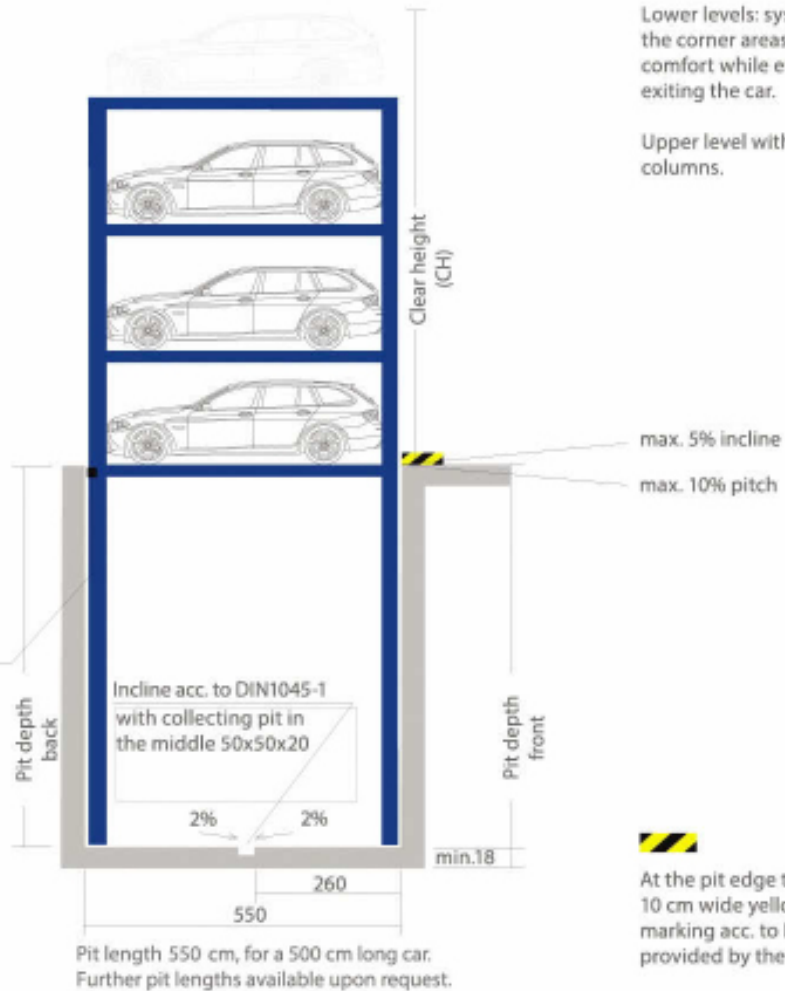

Lower levels: system columns in the corner areas for maximum comfort while entering and exiting the car.

Upper level without system columns.

max. 5% incline
max. 10% pitch

At the pit edge there is a 10 cm wide yellow-black marking acc. to ISO 3864 to be provided by the customer

| PIT DEPTH FRONT-BACK | CLEAR HEIGHT (CH) | CAR HEIGHT BELOW | CAR HEIGHT MIDDLE 1 | CAR HEIGHT MIDDLE 2 | CAR HEIGHT ABOVE |
|----------------------|-------------------|------------------|---------------------|---------------------|------------------|
| 570 | from 535 | 160 | 160 | 160 | from 155* |
| 600 | from 565 | 170 | 170 | 170 | from 155* |
| 630 | from 595 | 180 | 180 | 180 | from 155* |

* N4902-D:
Lifting with vehicle on the upper platform is NOT possible.

VEHICLE DATA: STANDARD CAR

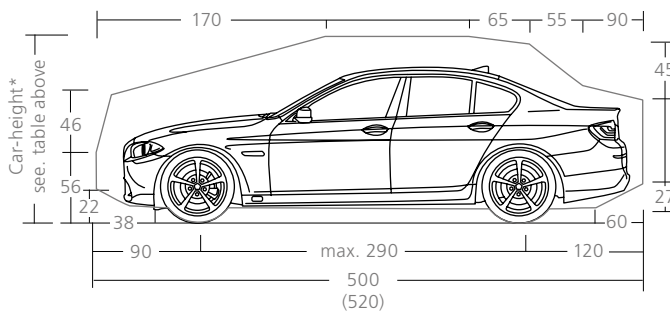

VEHICLE DATA: STANDARD ESTATE CAR

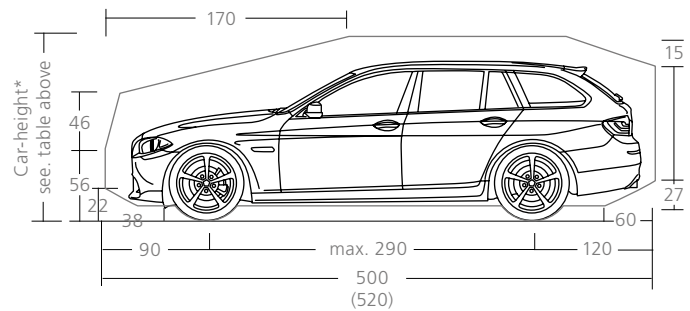

ELECTRICAL INSTALLATION AND FOUNDATION LOADS

Services covered by the MAP Company

| POS. | QTY. | DESCRIPTION |
|------|------|-------------------------------------------------------------------------------|
| 1 | 1x | Hydraulic power unit with three-phase motor 230/480V, 60Hz, 12kW (4x3,0kW) |
| 2 | 1x | Control line 4x 1,0 ² (for the standard key-operated switch) |
| 3 | 1x | Control line 7x 1,0 ² (for the locking of the key-operated switch) |
| 4 | 1x | Control element |
| 5 | 1x | Control line 5x 6,0 mm ² |

Positions 1 to 5 are covered by the MAP company unless otherwise agreed in the offer or in the contract.

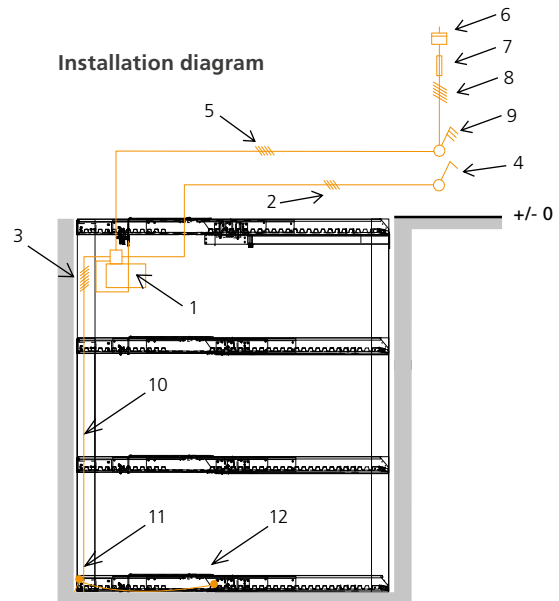

Services to be provided by the customer

| POS. | QTY. | DESCRIPTION | POSITION | FREQUENCY |
|------|------|---------------------------------------------------------------------------------------------------------------------|---------------------|---------------|
| 6 | 1x | Electricity meter | in the supply line | |
| 7 | 1x | Blade fuse or circuit breaker 3x 32A, slow acc. to DIN VDE 0100 part 430 | in the supply line | 1x power unit |
| 8 | 1x | Supply line 5x 6,0 mm ² (3 PH + N + PE) with marked leads + protective earth conductor | to the mains switch | 1x power unit |
| 9 | 1x | Lockable network facility (main control switch) | near power unit | 1x power unit |
| 10 | 1x | Empty pipe DN 40 with taut wire to the power unit and control panel | acc. to project | 1x power unit |
| 11 | 1x | Foundation earth electrodes | pit floor corner | 1x pit |
| 12 | 1x | Equipotential bonding according to DIN EN 60204 from the connector of the foundation earth electrodes to the system | on the pit floor | 1x system |

FOUNDATION LOADS AND CONSTRUCTION

Foundation and pit walls must be planned so that they can absorb the loads of the parking system according to the schematic diagram shown below. All forces are discharged to the ground by base plates with a minimum area of 150cm². The base plates of the parking system are fastened with metal heavy duty anchor bolts; the borehole is approx. 14cm deep. Optionally, instead of metal heavy duty anchor bolts, the base plates can be fastened using shear connectors, e.g. in case of watertight concrete or increased noise insulation. The clarification of the fastening methods shall be provided by the customer, if necessary, the shear connectors can be delivered against surcharge.

Foundation, walls and ceilings shall be provided by the customer and completed prior to assembly start and must be true to size, clean and dry. Floor and walls (below the entrance level) made of armoured concrete, concrete quality at least: C25/30.

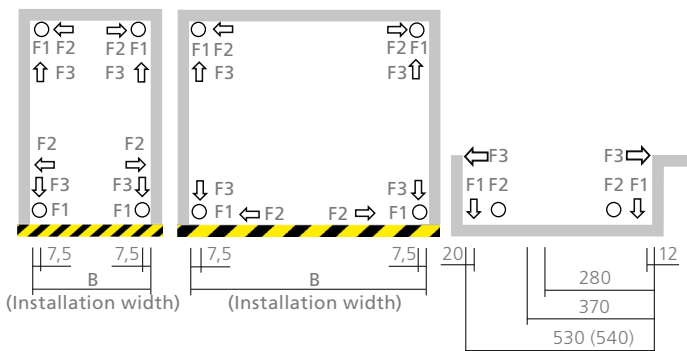

| LOADS F | SINGLE SYSTEM 2.000KG | DOUBLE SYSTEM 2.000KG | SINGLE SYSTEM 2.600KG | DOUBLE SYSTEM 2.600KG |
|---------|--------------------------|--------------------------|--------------------------|--------------------------|
| F1 | 33 kN | 45 kN | 40 kN | 60 kN |
| F2 | 10 kN | 12 kN | 11 kN | 16 kN |
| F3 | +/-1 kN | +/-1 kN | +/-1 kN | +/-1 kN |

Dimensions in cm. All Dimensions are minimum dimensions. Tolerances shall be taken into account additionally, see page „width dimensions for garages“.

WIDTH DIMENSIONS AND PIT FLOOR

All dimensions in cm. All dimensions are minimum dimensions. Advice for planning and tendering: Generally masonry and concrete works are to be conducted according to the German norm VOB/C (DIN 18330 and DIN 18331). In the mentioned norm are pointed the tolerances that are to be fulfilled according to DIN 18202. In this norm are defined the maximum permissible dimension variations as exceedance and shortfall of the nominal size. The nominal size should be planned in order to meet the minimum dimensions necessary for the parking system.

PARTITION WALLS

Single system for 2 cars



Double system for 4 cars

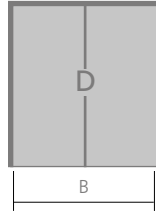

Double system + single system for 6 cars

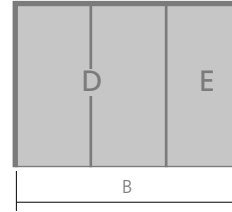

Driving lane width
acc. to country specific regulations.

| CLEAR PLATFORM WIDTH | INSTALLATION WIDTH B | CLEAR PLATFORM WIDTH | INSTALLATION WIDTH B | CLEAR PLATFORM WIDTH | INSTALLATION WIDTH B |
|----------------------|----------------------|----------------------|----------------------|----------------------|----------------------|
| 230 | 270 | 460 | 505 | 460+230 | 775 |
| | | 470 | 515 | • | |
| 240 | 280 | 480 | 525 | 480+240 | 805 |
| | | 490 | 535 | • | |
| 250 | 290 | 500 | 545 | 500+250 | 835 |
| | | | | | |
| 260 | 300 | | | | |

The power unit is installed on the system and moves with the system.

INFORMATION ABOUT THE PIT FLOOR

The pit floor should be built according to the drawing on the right. The four corners, on this surface are the lifting cylinders. These surface must have dimensions 50 x 50 cm and must be even.

In the middle of the pit floor there must be a sump hole in which there must be installed a pump to draw the water that may fall in the pit while dripping from cars or from the sides of the pit and brought out of the pit by a hose. Local regulations for prevention of water pollution shall be observed.

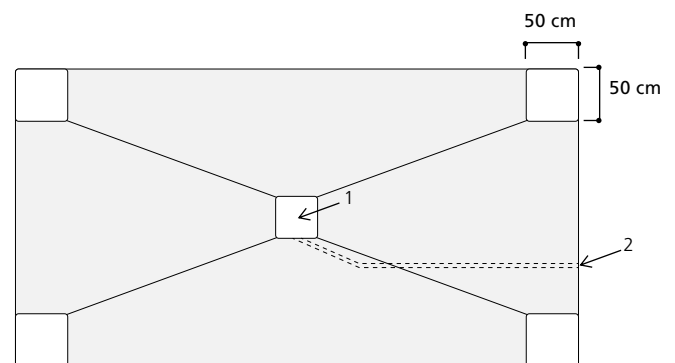

1. Sump hole with pump. Surrounding surfaces' incline to the middle: approx. 2%
2. Drainage pipe to connect to the existing drainage system

For maintenance purposes, in emergency cases, the system can be brought to its basis position (lowered) by unscrewing the upper platform. In case the upper platform is covered with other materials than trapezoidal metal sheet, a shaft shall be built on the side of the pit in order to provide the possibility to come into the pit and maintain the system as the material covering the upper platform can't be unscrewed or removed.

The wall thickness of the pit depends on the loads from outside and must be calculated individually for each pit and each system.

STANDARD FEATURES – IN THE SCOPE OF DELIVERY

NOTE

We suggest periodical maintenance, care and cleaning. Take advantage of MAP maintenance agreements.

COMPONENT PARTS

Single system: consisting of 4 single platforms, 4 Telescope columns with hydraulic cylinders, path measurement system, hydraulic block and piping

and/or:

Double system: consisting of 4 double platforms 4 telescope columns with hydraulic cylinders, path measurement system, hydraulic block and piping

DRIVING SHEETS

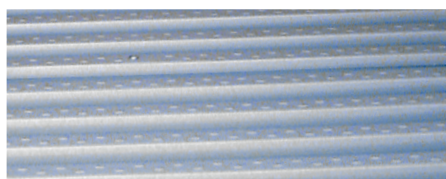

Platforms with sidewalls and driving sheets made of trapezoidal sheet.

DIMENSIONS OF THE SYSTEM

Parking space length: 500 cm
 Parking space width: 230 cm
 Pit depths: 350 cm (S-system),
 370 cm (D-system)
 Load per parking space up to 2.000 kg.

DOCUMENTATION

Brief operating instructions (fastened to the control unit), documentation (test book and operating instructions).

ELECTRICAL INSTALLATION

For a list of services and interfaces please see the respective table in this brochure.

LOCKABLE KEY SWITCH



Control unit consisting of a lockable key switch (key can be taken off only in the basis position) with emergency-off in dead-man's control. Lifting and lowering by using the respective button.

HYDRAULIC POWER UNIT

Power unit „Silencio“ and control switch



With hydraulic canalization and cabling to the main control switch. (The under oil unit is not loud thanks to the motor-pumps-combination that absorbs sound and insulates form noise).

Measurements of the power unit + mains switch: 115 x 25 x 75 cm.

Position of the power unit:

The power unit is fastened on the system and each system is provided with its own power unit.

The power unit will be installed on the left side of the lower platform.

CORROSION PROTECTION

C3-Line

For Regions with average snowfall and humidity levels (standard in Germany).

C2-Line

Recommended only for regions with small or no snowfall and low humidity levels.

PATH MEASUREMENT SYSTEM

Path measurement system for synchronizing the 4 lifting cylinders of the Quadroparker N4904

SAFETY DEVICES

- „Kommando-Folge-cylinder“ (cross-mounted) to improve platforms' synchronous drive by unequal load charge.
- Safety device to avoid lowering in case of pipeline rupture.
- Parking system and hydraulic power unit fastened by stud-bolts, electrical cabling fastened by impact dowels.
- Handrails on the platforms where necessary to avoid danger of falling down from the system.

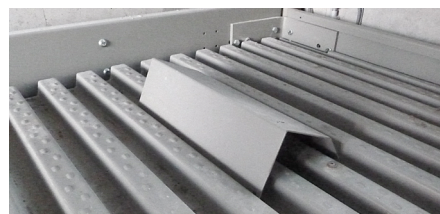

- Wedge to help position the vehicle.

Note:

- Safety fences against shear and crushing points are a priority and must be provided by the customer.

OPTIONS AND EXTRA EQUIPMENT

Available upon request - Examples

DIMENSIONS OF THE SYSTEM

Parking space length: from 510 to 540 cm

Parking space width: from 240 to 250 cm
(S-system up to 260 cm)

Parking space height: from 160 to 180 cm

Pit depths: from 600 to 630 cm.

Fastening of the parking system with chemical anchors in case of heightened foundation requirements or sound insulation.

VEHICLE WEIGHT

Higher load per parking space:
up to 2.300 kg or 2.600 kg.

WEATHERPROOF CASING AND SUPPORTING PILLAR



Optionally with the key switch it is possible to deliver the following features:

- Weatherproof casing for the key switch.
- Supporting pillar for the key switch.

MOBILE SAFETY FENCES

The basis configuration is provided with wired grating. Alternatively it is possible to get plastic plates as safety fence.

DRIVING SHEETS



Upper platforms with Aluminium-bulb plates driving sheets and special driving wedge to help position the vehicle.

UPPER PLATFORM COVERINGS

It is possible to deliver a special covering for the upper platform. For more information see next page. Details upon request.

LAUFSTEGE

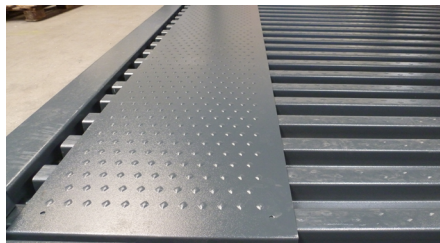

Catwalk on trapez. sheet for more walking comfort

For better walking comfort
Positioned on the left side of the parking space. 1,5 mm galvanized sheet, coined surface area. The catwalk is bolted to the driving sheet.

CARPORT

It is possible to deliver a mobile roof for the system. For more information see next page. Details upon request.

NOTE

We suggest periodical maintenance, care and cleaning. Take advantage of MAP maintenance agreements.

CORROSION PROTECTION

C4-Line: driving sheets powdered on both sides.

For regions with highly corrosive humidity levels.

HYDRAULIC

- HVLP 32-330 oil for extreme temperature variations.
- Heated hydraulic power unit.

EXTRA SOUND INSULATION

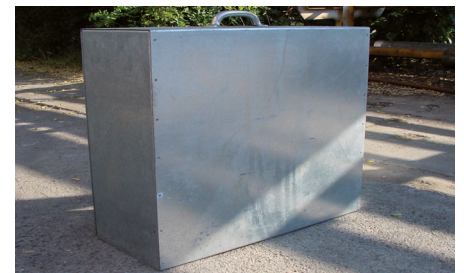

Sound insulation hood for the power unit

Airborne noise package

For the power unit to reduce the airborne noise.

Structure/borne noise package

Measures to reduce the sound propagation from the parking system to the building.

Note

- In order to comply with the DIN 4109/A1 Table 4 - requirements for the allowed noise level in areas in need of protection from noises coming from the technical equipment, the perimetral parts of the garage building shall be built with a sound reduction index R_w' of at least 57 dB.

NOTE

Frame constructions cause a loss in the lower parking space height.

OPTIONAL CONFIGURATION POSSIBILITIES

The fitting solution for every situation. Ask us!

UPPER PLATFORM COVERINGS - AS DECORATION

Upon request it is possible to install special coverings on the upper platform. These coverings are available in different materials and configurations so that they can adapt to the existing floor.



Gravel covering

Gravel-plants covering



Rubber covering in stone structure (3 cm thick)



Synthetic stone covering (3 cm thick)



Wooden covering

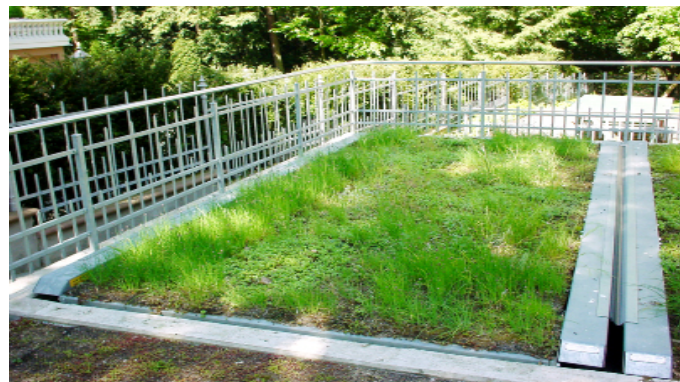

Greenery

SERVICES TO BE PROVIDED BY THE CUSTOMER AND PLANNING INDICATIONS

During the planning phase please observe and comply with the following notes!

SERVICES TO BE PROVIDED BY THE CUSTOMER

Safety fences

Safety fences acc. to DIN EN ISO 13857 must be provided by the customer.

Parking spaces' numeration

For the allocation of the parking spaces we suggest our customers to numerate the parking spaces.

Noise abatement measures

The compliance with these measures must be carried out by the customer acc. to norm DIN 4109: „Sound insulation in building construction“.

Lighting

To be carried out by the customer acc. to DIN 67528: „Lighting for parking areas and indoor car parks“.

Pit-foundation

To be carried out by the customer acc. to the specifications in this brochure.

Electrical installation

Prior to starting the assembly the customer must provide a lockable main control switch out of the system/pit and close to the power unit. Electrical services to be provided by the customer acc. to this brochure's spec.

Installation requirements

The compliance with installation requirements acc. to quotation.

Drainage

Drainage channel 10 cm x 10 cm with collecting pit 50 cm x 50 cm x 20 cm acc. to this brochure's spec to be carried out by the customer.

Fire protection

The customer must agree upon the fire protection requirements and the required measures with the local fire department and realise them.

Marking

The customer must provide a 10 cm wide yellow-black marking on the front pit edge according to the norm ISO 3864.

Wall openings

In case of partition walls the customer must realise a 10 cm x 10 cm wall opening for hosting hydraulic and electrical cables.

Building permit

The customer must apply for and get the required permits in order to allow the installation of the parking system.

Control unit

The customer must make sure that a plain surface of (L x W) 50 cm x 20 cm for the installation of the control unit is directly close to the power unit and out of the platforms' moving area.

PLANNING INDICATIONS

Parking space width and driving lanes

While planning the parking space and driving lane dimensions please observe and comply with the local/national prescriptions for the Garages' construction. For more parking comfort we suggest you to plan parking spaces of at least 250 cm width.

Group of users

Our parking systems are conceived for a permanent and instructed group of users.

Maintenance and care

We suggest a timely conclusion of a maintenance agreement.
We suggest also to perform maintenance, care and cleaning at regular time intervals.

EG-Machinery directive

Our parking systems comply with the EG-Machinery directive and are CE certified according to the norm DIN EN 14010.

Ramps' inclination

Ramps leading to garages shall not have more than 15% inclination.

Modifications

The company MAP Parking GmbH reserves the right to make dimensional, design and technical modifications.